

# X10 OCS MODEL: HE-X10



**MODEL A BUILT-IN I/O: 12 DIGITAL IN, 12 DIGITAL OUT, 4 ANALOG IN/RTD IN, 2 ANALOG OUT**  
**MODEL R BUILT-IN I/O: 12 DIGITAL IN, 6 RELAY OUT, 2 PWM OUT, 4 ANALOG IN/RTD IN, 2 ANALOG OUT**

## 1 TECHNICAL SPECIFICATIONS

### 1.1 General

Primary Pwr. Range	9 - 30VDC	
	<b>X10A</b>	<b>X10R</b>
Typical power backlight 100%	305mA @ 24V	295mA @ 24V
Typical Power backlight 50%	205mA @ 24V	200mA @ 24V
Power Backlight Off	140mA @ 24V	140mA @ 24V
Inrush Current	30A < 1ms	
Real Time Clock	Battery backed; lithium coin cell CR2450	
Battery Life	7 -10 years	
Clock Accuracy	+/- 90 secs/month @ 20°C	
Relative Humidity	5 to 95% Non-condensing	
Operating Temp.	-10°C to +60°C	
Storage Temp.	-20°C to +70°C	
Pollution Degree	2	
Altitude	Up to 2000m	
Weight	39 oz. / 1105.6g	
Mounting Clips	4, metal	
Housing Material	Polycarbonate, UL rated	
Panel Seal	Silicone rubber	
Front Panel	Type 1, 4X indoor use only, 12, 12K and 13	
Packaging	100% Recyclable paper fiber materials	
Included in Box	Controller, 3 x I/O connectors, 4 x mounting clips, 1 x power connector, Quick Reference Guide	

### 1.2 Testing

Shock	IEC 60068-2-27
Vibration	IEC 60068-2-6
UL Environmental Ratings	Type 1, 4, 4X, 12, 12k & 13 for indoor use
Certifications (UL/CE)	USA: <a href="https://hornerautomation.com/certifications/">https://hornerautomation.com/certifications/</a> Europe: <a href="https://www.horner-automation.eu/support/certifications-2/">https://www.horner-automation.eu/support/certifications-2/</a>

### 1.3 User Interface

Display	10" Wide
Resolution	1024 x 600
Backlight	White LED
Backlight Lifetime	50,000 hours to reach 50% brightness, typically
Backlight Control	Software controlled: 0 to 100% dimmable
User-Programmable Screens/Pages	250
No. of Objects/Screens	100
Screen Memory	6.75MB
Keypad	Touchscreen
Tactile Feedback	Optional Sound
Number of Keys	Touch system and 5 function keys

### 1.4 Control & Logic

Control Language Support	Advanced ladder logic Full IEC 61131-3 languages
Logic Program Size	256kB
Non-Retentive Memory	128kB
Internal Storage Memory	16Mb
Total Program Memory	2.5Mb
Logic Scan Rate	0.4ms/kB
%I (Digital Inputs)	1024
%Q (Digital Outputs)	1024
%AI (Analog Inputs)	256
%AQ (Analog Outputs)	256
%M (Retentive Bits)	1024
%T (Temporary Bits)	1024
%R (Retentive Registers)	5000
%D (Display Bits)	250
%K (Key Bit)	5
%S (Status Bits)	13
%SR (System Registers)	255

### 1.5 Connectivity

Serial Ports	1 x RS232, 1 x RS485
485 Terminations	On-board, software controlled
Mini USB	Programming Only
CAN Hardware	CAN 2.0B
CAN Port Connector	RJ45 (Red)
CAN Port Speeds Support	125kB, 250kB, 500kB, 1Mb
CAN Protocols	CsCAN
Ethernet	1 x 10Mbps/100Mbps
Removable Memory In	microSD (SDHC, SDXC IN FAT32 format, support for 32GB max. Application Updates, Datalogging, more)

### 1.6 I/O Connections

Terminal Type	Removable 3.5 m color-coded
I/O Options	Onboard + Remote-SmartMod, SmartRail, SmartBlock, SmartStix

### 1.7 Inputs/Outputs Model Overview

	MODEL R	MODEL A
DC In	12	12
DC Out	2	12
Relays	6	-
HS In	4	4
HS Out	2	2
mA In/RTD	4	4
mA Out	2	2

There are four high-speed inputs (I9-I12) of the total DC Inputs.  
 There are two high-speed outputs (O1-O2) of the total DC outputs.

Model A DC outputs are sourcing.

Model R DC outputs are sinking with integral pull up resistors.  
 Model R also supports sourcing.

## technical specifications continued...

### 1.8 Digital DC Inputs: Models R & A

Inputs per Module	12 Including 4 Configurable HSC Inputs	
Commons per Module	1	
Input Voltage Range	12VDC / 24VDC	
Absolute Max. Voltage	35VDC Max.	
Input Impedance	10kΩ	
<b>Input Current:</b>	<b>Positive Logic</b>	<b>Negative Logic</b>
Upper Threshold	0.8mA	-1.6mA
Lower Threshold	0.3mA	-2.1mA
Min ON Threshold	8VDC	
Max OFF Threshold	3VDC	
OFF to ON Response	0.1ms	
ON to OFF Response	0.1ms	
Number of High Speed Counters	4	
Maximum Frequency	500kHz	
Accumulator Size	32-bits each	
Modes Supported	Totalizer, quadrature, pulse measurement, frequency measurement, set-point controlled outputs	

### 1.9 Model R: Digital DC Outputs, Sinking, Sourcing

Outputs per Module	2 (PWM or HSC)	
Commons per Module	1	
Type	Sinking	
Absolute Max. Voltage	28VDC	
Output Protection	Short circuit	
Max. Output per Point: <b>Sinking</b>	0.5A	
Max. Output per Point: <b>Sourcing</b>	2.4mA @ 24V	
Max. Voltage Drop at Rated Current	0.25VDC	
Max Outrush	650mA	
	<b>Min</b>	<b>Max</b>
OFF to ON Time (typical)	2.2μs	2.2μs + scan time
ON to OFF Time (typical)	13μs	13μs + scan time
PWM Out	65kHz	
Rise Time	2.4μs (typical @ 24V)	
Fall Time	7.5μs (typical @ 24V)	

### 1.10 Relay Outputs: Model R

Outputs per Module	6 Relay
Relay Contact Type	Floating
Max. Output Current per Relay	3A @ 60VAC, resistive 3A @ 30VDC, resistive
Max. Total Output Current Combined Relays	5A continuous
Max. Output Voltage	3A @ 60VAC, resistive 3A @ 30VDC, resistive
Max. Switched Power	150W
Contact Isolation to Ground	1000VAC
Max. Voltage Drop at Rated Current	0.5V
Expected Life (see derating chart on page 3)	No Load: 5,000,000 Rated Load: 100,000
Max. Switching Rate	300 CPM at no load 20 CPM at rated load
Type	Mechanical Contact
Response Time	One update per ladder scan plus 10 ms

### 1.11 Model A: Digital DC Outputs, Sourcing

Outputs per Module	12 Including 2 Configurable PWM Outputs	
Commons per Module	2	
Type	Sourcing	
Absolute Max. Voltage	28VDC	
Output Protection	Short Circuit, Thermal, Undervoltage	
Max. Voltage Drop at Rated Current	0.25VDC	
Max Output per Point: Sourcing	0.5A @ 24VDC	
	<b>Min</b>	<b>Max</b>
OFF to ON Time (typical)	300ns	500ns + scan time
ON to OFF Time (typical)	300ns	475ns + scan time
PWM Out	65kHz	
Rise Time	150ns Max	
Fall Time	150ns Max	

### 1.12 Analog Inputs: Models R & A

Number of Channels	4	
Input Ranges	0-20mA; 4-20mA; PT100 RTD	
RTD Temperature Range	-58° to 392°F (-50° to 200°C) PT100 DIN	
Nominal Resolution	12 Bits	
Resolution	0.5°C	
Safe Input Voltage Range	-0.5V to 12V, protection up to 24V	
Input Impedance (clamped @ -0.5VDC to 12VDC)	Current Mode: 100Ω	
%AI Full Scale	10V, 20mA, 100mV: 32,000 full scale RTD: 20 counts/°C	
Max. Over Current	25mA	
Max Error at 25°C (excluding Zero) Adjusting Filtering may Tighten	< 1.5% of full scale	
Filtering	Select filter (0-7) to set 1-128 Scan Digital Running Average Filter	

### 1.13 Analog Outputs: Models R & A

Number of Channels	2
Output Ranges	4-20mA -
Nominal Resolution	12 Bits
Update Rate	Once per PLC scan
Max. Error at 25°C (Excluding Zero)	< 1.5% of full scale
Maximum 20mA Load	500Ω
% AQ Full Scale	32,000
Protection	Protect against miswire up to 24VDC auto-recover

#### Removing and Inserting Connectors:

Use a small screwdriver to gently pry up the connector. Gently press on connector to snap into place.

#### Wiring Details:

**Solid/Stranded wire:** 12-24 awg (2.5-0.2mm).  
**Strip length:** 0.28" (7mm)  
**Torque rating:** 4.5 - 7 in-lbs (0.50 - 0.78 Nm).

## 2 CONTROLLER OVERVIEW

### 2.1 - Port Connectors



1. Touch Screen
  2. High-capacity microSD Slot
  3. RS232/RS485 Serial Connector, CAN port (via RJ45), LAN Port (Ethernet)
  4. USB Mini-B Port
  5. Analog I/O, DC Inputs, DC Outputs
  6. DC Power
- NOTE: See Precaution #12 on p.7 about USB and grounding.

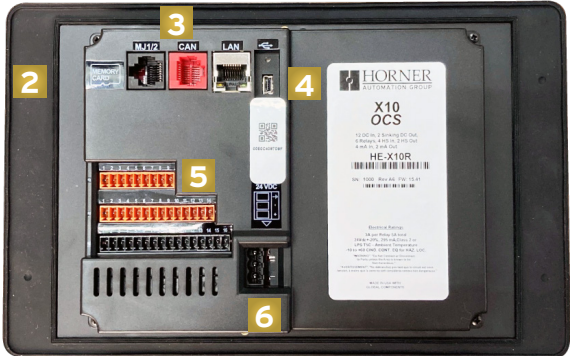

### 2.2 - Power Wiring

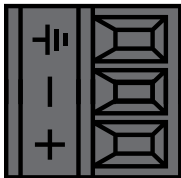

Primary Power Port Pins		
PIN	SIGNAL	DESCRIPTION
1	Ground	Frame Ground
2	DC-	Power Supply Common
3	DC+	Power Supply Voltage

#### DC Input / Frame

Solid/Stranded Wire: 12-24 awg (2.5-0.2mm).  
 Strip Length: 0.28" (7mm).  
 Torque Rating: 4.5 - 7 in-lbs (0.50 - 0.78 Nm).  
 DC- is internally connected to I/O V-.  
 A Class 2 power supply must be used to meet UL requirements.

#### POWER UP

1. Attach included ferrite core\* with a minimum of two turns of the DC+ and DC- signals from the DC supply that is powering the controllers.



2. Connect to Earth ground.
3. Apply the recommended power.

\*See Accessories section on page 7.

## 3 WIRING: INPUTS AND OUTPUTS

### 3.1 - Digital Inputs

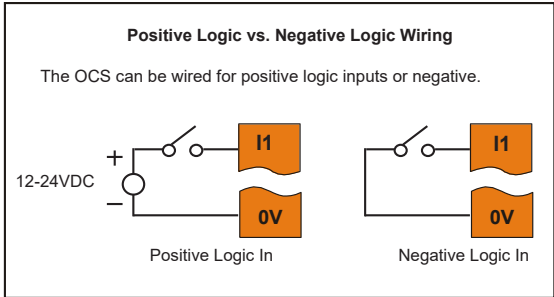

Digital inputs may be wired in either a Positive Logic or Negative Logic fashion as shown. The setting in the Cscape Hardware Configuration for the Digital Inputs must match the wiring used in order for the correct input states to be registered.

### 3.2 - Relay Life Expectancy

Micro OCS Relay Life Expectancy	
Mechanical Endurance	10,000,000 ops Min. (no load)
Electrical Endurance	100,000 ops Min. (rated load)

### 3.3 - Analog Inputs Information

Raw input values are found in the registers as Integer-type data with a range from 0 - 32000.  
 Analog inputs may be filtered digitally with the Filter Constant found in the Cscape Hardware Configuration for Analog Inputs. Valid filter values are 0 - 7 and act according to the following chart.

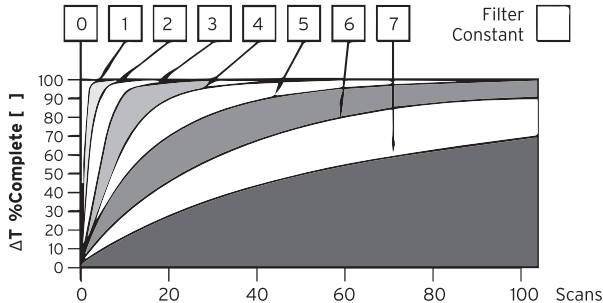

Data Values	
INPUT MODE:	DATA FORMAT, 12-bit INT:
0-20mA, 4-20mA	0-32000
RTD	20 Counts/ °C

## wiring: I-O continued...

### 3.4 - Sourcing & Sinking Wiring on Model R

Model R: Sourcing Outputs [2.4mA @ 24V]

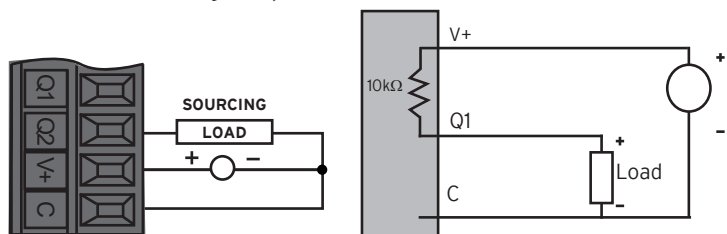

Model R: Sinking Outputs [Outputs can sink 500mA]

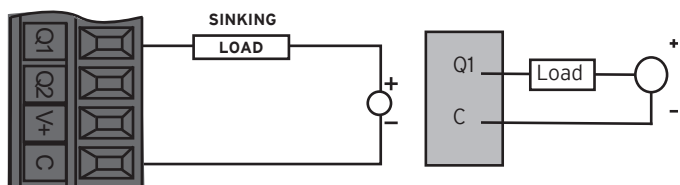

### 3.5 - J1 Wiring

#### J1 Wiring Model A - Digital Out

POSITION/PIN	DIGITAL MODEL	DIGITAL MODEL
1	Q1	Output 1 (PWM)
2	Q2	Output 2 (PWM)
3	Q3	Output 3
4	Q4	Output 4
5	V+	External V+
6	C	Common
7	Q5	Output 5
8	Q6	Output 6
9	Q7	Output 7
10	Q8	Output 8
11	Q9	Output 9
12	Q10	Output 10
13	Q11	Output 11
14	Q12	Output 12
15	V+	External V 2 +
16	C	Common

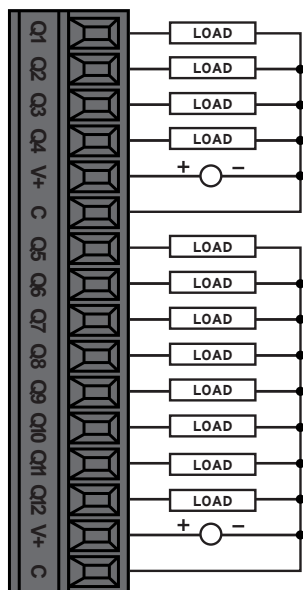

#### J1 Wiring: Model R - Relay and Digital Out

POSITION/PIN	DIGITAL MODEL	DIGITAL MODEL
1	R1	Relay 1 N.O.
2	C1	Relay 1 C
3	R2	Relay 2 N.O.
4	C2	Relay 2 C
5	R3	Relay 3 N.O.
6	C3	Relay 3 C
7	R4	Relay 4 N.O.
8	C4	Relay 4 C
9	R5	Relay 5 N.O.
10	C5	Relay 5 C
11	R6	Relay 6 N.O.
12	C6	Relay 6 C
13	Q1	Output 1
14	Q2	Output 2
15	V+	External V+
16	C	Common

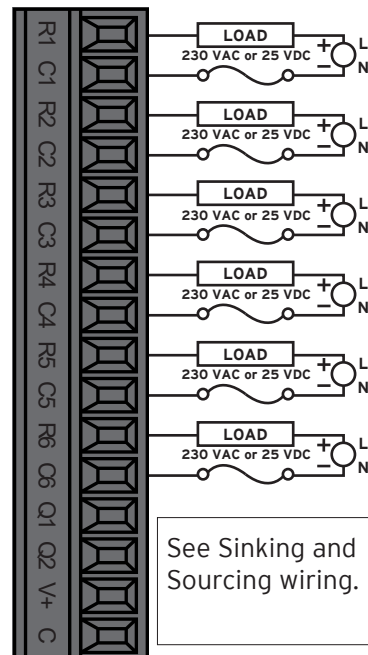

See Sinking and Sourcing wiring.

NOTE: Internal 10kΩ resistors between: V+ and Q1; V+ and Q2

### 3.6 - J2 Wiring

#### J2 Wiring: Model R & Model A - Digital Input

POSITION/PIN	DIGITAL MODEL	DIGITAL MODEL
1	I1	Input 1
2	I2	Input 2
3	I3	Input 3
4	I4	Input 4
5	I5	Input 5
6	I6	Input 6
7	I7	Input 7
8	I8	Input 8
9	I9	Input 9 (HSC1)
10	I10	Input 10 (HSC2)
11	I11	Input 11 (HSC3)
12	I12	Input 12 (HSC4)
13	C	Common
14	C	Common

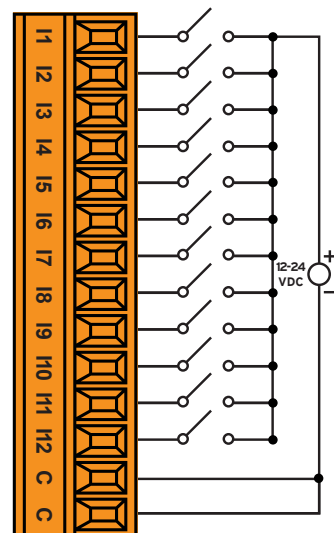

## wiring: I-O continued...

### 3.7 - J3 Wiring - Models A & R

#### RTD: 2 x 3 - Wire RTD & 2 x 4-20mA Output

PIN	Wire	Connection
1	AI1	RTD Sense
2	R1+	RTD Excitation
3	AI2	RTD Sense
4	R2+	RTD Excitation
5	AI3	No Connection
6	R3+ or AQ1	mA Output
7	AI4	No Connection
8	R4+ or AQ2	mA Output
9	C	Common

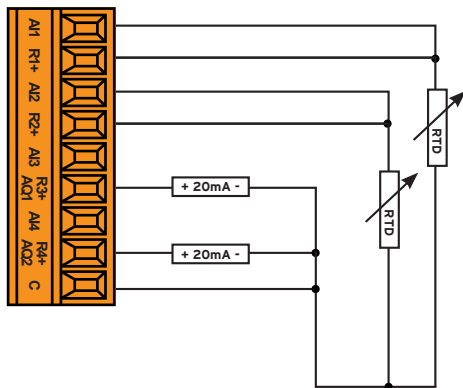

If AQ1 is used, RTD3 is unavailable.  
If AQ2 is used, RTD4 is unavailable.

#### RTD: 4 x 2 - Wire RTD Connection

PIN	Wire	Connection
1	AI1	RTD Sense
2	R1+	RTD Excitation
3	AI2	RTD Sense
4	R2+	RTD Excitation
5	AI3	RTD Sense
6	R3+ or AQ1	RTD Excitation
7	AI4	RTD Sense
8	R4+ or AQ2	RTD Excitation
9	C	Common

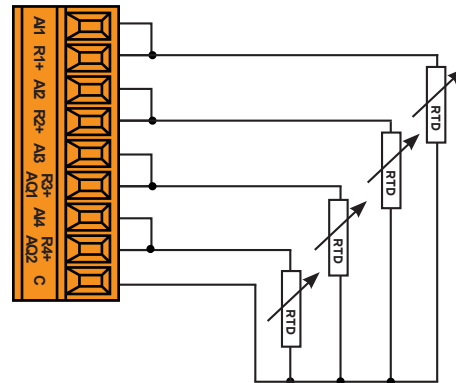

If AQ1 is used, RTD3 is unavailable.  
If AQ2 is used, RTD4 is unavailable.

#### 4 x 4 - 20mA Input / 4-20mA Output

PIN	Wire
1	AI1
2	R1+
3	AI2
4	R2+
5	AI3
6	R3+ or AQ1
7	AI4
8	R4+ or AQ2
9	C

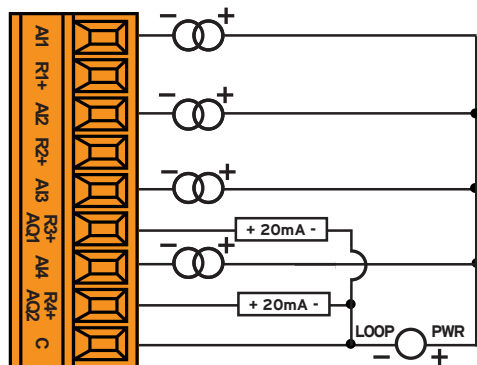

If AQ1 is used, RTD3 is unavailable.  
If AQ2 is used, RTD4 is unavailable.

#### RTD: 4 x 3 - Wire RTD Connection

PIN	Wire	Connection
1	AI1	RTD Sense
2	R1+	RTD Excitation
3	AI2	RTD Sense
4	R2+	RTD Excitation
5	AI3	RTD Sense
6	R3+ or AQ1	RTD Excitation
7	AI4	RTD Sense
8	R4+ or AQ2	RTD Excitation
9	C	Common

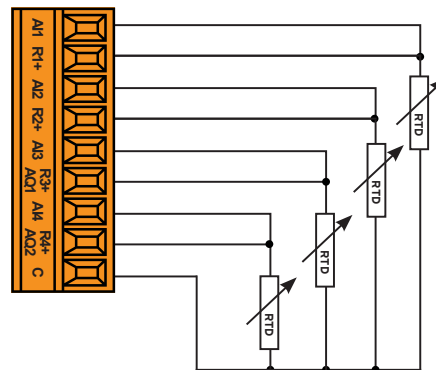

If AQ1 is used, RTD3 is unavailable.  
If AQ2 is used, RTD4 is unavailable.

### 3.8 - Ex: Universal Input Wiring Schematic

20mA Analog In - Not Self Powered

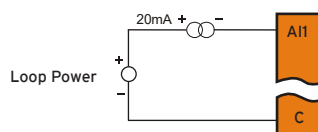

RTD In

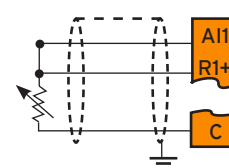

20mA Analog In - Self Powered

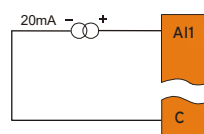

4 - 20mA Analog Out

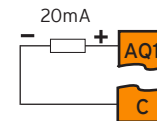



## 4 COMMUNICATIONS

### 4.1 - CAN Communications

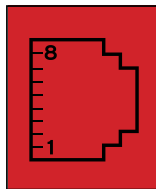

**CAN** - Modular jack (8 posn RJ45)

#### CAN Pin Assignments

PIN	SIGNAL
8	No Connection
7	Ground
6	Shield
5	No Connection
4	No Connection
3	Ground
2	CAN Data Low
1	CAN Data High

The CAN port is provided via the single 8-position modular jack labeled "CAN". It may be used to communicate with other OCS products using Horner's CsCAN protocol. Additionally, remote expansion I/O such as SmartRail, SmartBlock, and SmartStix may be implemented using the CsCAN protocol.

Termination for the CAN port may be enabled from the System Menu or System Register. This should only occur if the X10 is at either end of the CAN network. Only the two devices on either end of the CAN network should be terminated.

### 4.2 - Serial Communications

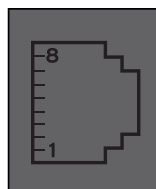

**MJ1:** RS-232 w/full handshaking

**MJ2:** RS-485 half-duplex

RS-485 termination and biasing via System Menu or System Register

#### MJ1 & MJ2 PINS

PIN	SIGNAL	DIRECTION
8	TXD	OUT
7	RXD	IN
6	OV	Common
5	+5V @ 60mA	OUT
4	RTS	OUT
3	CTS	IN
2	RX-/TX-	IN/OUT
1	RX+/TX+	IN/OUT

Attach optional ferrite core with a minimum of two turns of serial cable. See Accessories for more details. See Accessories on page 7.

### 4.3 - Ethernet Communications

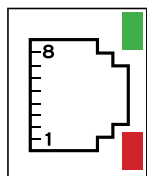

Link Indicator

Activity Indicator

10/100 Ethernet port with automatic MDI-X (crossover detection) is provided via the single 8-position modular jack labeled "LAN". Several features are available for use over Ethernet: ICMP (Ping), EGD (Ethernet Global Data), Modbus Slave, Ethernet / IP, FTP (File Server), and ASCII over TCP/ IP.

Ethernet configuration is done via the Cscape Hardware Configuration, though temporary Ethernet configuration may be done through the System Menu directly on the X10.

For more information on the Ethernet, available features and protocols, refer to the Ethernet Supplement document (SUP0740).

## 5 BUILT-IN I/O: MODELS A & R

Both X10 models feature built-in I/O. The I/O is mapped into OCS Register space, in three separate areas - Digital/Analog I/O, High-Speed Counter I/O, and High-speed Output I/O. Digital and analog I/O location is fixed starting at 1, but the high-speed counter and high-speed output references may be mapped to any open register location.

FIXED ADDRESS	I/O FUNCTION	MODEL R	MODEL A
%I	Digital Inputs	1-12	1-12
	Reserved	13-32	13-32
%Q	Digital Outputs	1-2	1-12
	Relay Outputs	3-8	--
%AI	Reserved	9-24	13-24
	Analog Inputs	1-4	1-4
%AQ	Reserved	5-12	5-12
	Analog Outputs	1-2	1-2
	Reserved	3-16	3-16

## 6 DIMENSIONS & INSTALLATION

### 6.1 Dimensions & Panel Cutout

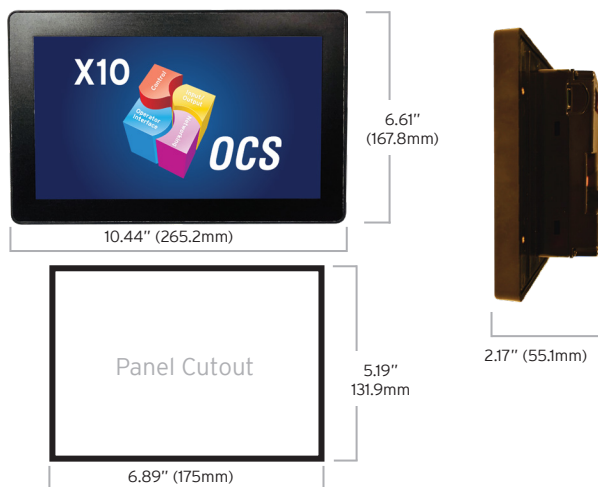

dimensions and installation continued on next page...

## dimensions and installation continued...

## 8 SAFETY

### 6.2 - Installation Procedure

This equipment is panel mounted and is meant to be installed in an enclosure suitable for the environment, such that the back of the equipment is only accessible with the use of a tool.

This equipment is suitable for use in Class I, Division 2, Groups A, B, C and D; Class II, Division 2 Groups F and G; and Class III Hazardous Locations or Non-Hazardous Locations only.

The X10 utilizes a clip installation method to ensure a robust and watertight seal to the enclosure. Follow the steps below for the proper installation and operation of the unit.

1. Carefully locate an appropriate place to mount the X10. Be sure to leave enough room at the top of the unit for insertion and removal of the microSD™ card.
2. Carefully cut the host panel per the diagram, creating a 175mm x 131.9mm (with a tolerance of +1.0mm/ -0.0mm) opening into which the X10 is to be installed. If the opening is too large, water may leak into the enclosure, potentially damaging the unit. If the opening is too small, the OCS may not fit through the hole without damage.
3. Remove any burrs/sharp edges and ensure the panel is not warped in the cutting process.
4. Install and tighten the four mounting clips (provided in the box) until the gasket forms a tight seal. For standard composite mounting clips (included with product). **NOTE: Torque Rating is 2-3 in-lbs (0.23-0.34 Nm). For optional metal mounting clips, use a torque rating of 4-8 in-lbs (0.45-0.90 Nm).**
5. Connect communications cables to the serial port, USB ports, and CAN port as required.

## 7 ACCESSORIES

### 7.1 Ferrite Core: HE-FBD001

A ferrite core is a type of magnetic core made of ferrite. It is a passive electronic component that can suppress high frequency signals on a power supply line or serial communication cable.

### 7.2 Backup Battery: HE-BAT009

The X10 uses a replaceable non-rechargeable 3V lithium coin-cell battery (CR2450) to run the Real-Time Clock and to maintain the retained register values. This battery is designed to maintain the clock and memory for 7-10 years. Please reference MAN1277 for instructions on how to replace the battery.

### 7.3 Programming Cable Kit: HE-XCK

The Programming Cable Kit ([HE-XCK](#)) includes the following adapter cables:

- USB to Mini USB
- USB to RS-232 Serial
- RS-2323 to RJ45 Ethernet

### 8.1 - WARNINGS

1. **WARNING** - Do not disconnect while circuit is live unless area is known to be non-hazardous. **AVERTISSEMENT** - Ne pas déconnecter pendant que le circuit est sous tension à moins que la zone ne soit connue pour être non dangereuse.
2. **WARNING - EXPLOSION HAZARD** - Do not disconnect equipment unless power has been removed or the area is known to be non-hazardous. **AVERTISSEMENT - RISQUE D'EXPLOSION** - Ne déconnectez pas l'équipement à moins que l'alimentation n'ait été coupée ou que la zone soit réputée non dangereuse.
3. To avoid the risk of electric shock or burns, always connect the safety (or earth) ground before making any other connections.
4. To reduce the risk of fire, electrical shock, or physical injury, it is strongly recommended to fuse the voltage measurement inputs. Be sure to locate fuses as close to the source as possible.
5. Replace fuse with the same type and rating to provide protection against risk of fire and shock hazards.
6. In the event of repeated failure, do NOT replace the fuse again as repeated failure indicates a defective condition that will NOT clear by replacing the fuse.
7. Only qualified electrical personnel familiar with the construction and operation of this equipment and the hazards involved should install, adjust, operate, or service this equipment. Read and understand this manual and other applicable manuals in their entirety before proceeding. Failure to observe this precaution could result in severe bodily injury or loss of life.
8. If the equipment is used in a manner not specified by Horner APG, the protection provided by the equipment may be impaired.

### 8.2 - FCC COMPLIANCE

This device complies with Part 15 of the FCC Rules. Operation is subject to the following two conditions:

1. This device may not cause harmful interference
2. This device must accept any interference received, including interference that may cause undesired operation

### 8.3 - PRECAUTIONS

All applicable codes and standards need to be followed in the installation of this product. Adhere to the following safety precautions whenever any type of connection is made to the module:

1. Connect the safety (earth) ground on the power connector first before making any other connections.
2. When connecting to the electric circuits or pulse-initiating equipment, open their related breakers.
3. Do NOT make connection to live power lines.
4. Make connections to the module first; then connect to the circuit to be monitored.
5. Route power wires in a safe manner in accordance with good practice and local codes.
6. Wear proper personal protective equipment including safety glasses and insulated gloves when making connections to power circuits.
7. Ensure hands, shoes, and floor are dry before making any connection to a power line.
8. Make sure the unit is turned OFF before making connection to terminals.
9. Make sure all circuits are de-energized before making connections.
10. Before each use, inspect all cables for breaks or cracks in the insulation. Replace immediately if defective.
11. Use copper conductors in Field Wiring only, 60/75°C.
12. Use caution when connecting controllers to PCs via serial or USB. PCs and laptops may use "floating power supplies" that are ungrounded which could cause a damaging voltage potential between the laptop and controller. Ensure the controller and laptop are grounded for maximum protection. Consider using a USB isolator due to voltage potential differences as a preventative measure.

## 9 PART NUMBER BUILDER

### GLOBAL MODEL NUMBERS

model

HE-X10

- R relay and solid state outputs
- A solid state output

## 10 TECHNICAL SUPPORT

For assistance and manual updates, contact Technical Support at the following locations:

**North America**  
(317) 916-4274  
www.hornerautomation.com  
techsppt@heapg.com

**Europe**  
(+) 353-21-4321-266  
www.hornerautomation.eu  
technical.support@horner-apg.com