

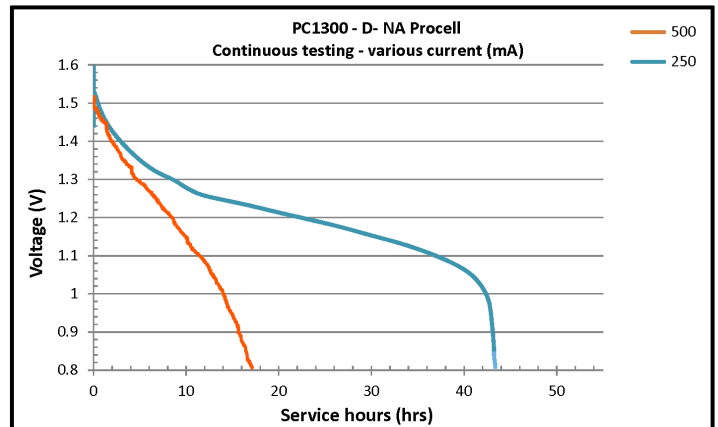

<b>Nominal voltage</b>	1.5 V
<b>Impedance</b>	136 m-ohm @ 1 kHz
<b>Typical weight</b>	139 g (4.9 oz)
<b>Typical volume</b>	56.4 cm <sup>3</sup> (3.4 in <sup>3</sup> )
<b>Terminals</b>	Flat
<b>Storage temperature range</b>	5°C to 30°C (41°F to 86°F)
<b>Operating temperature range</b>	-20°C to 54°C (-4°F to 130°F)
<b>Designation</b>	IEC: LR20 ANSI: 13A

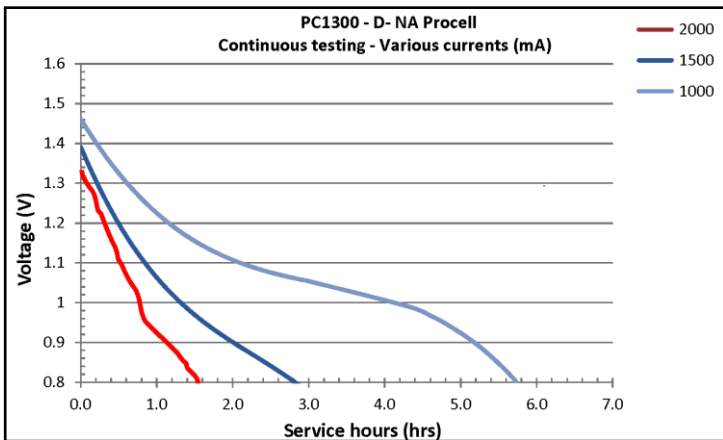
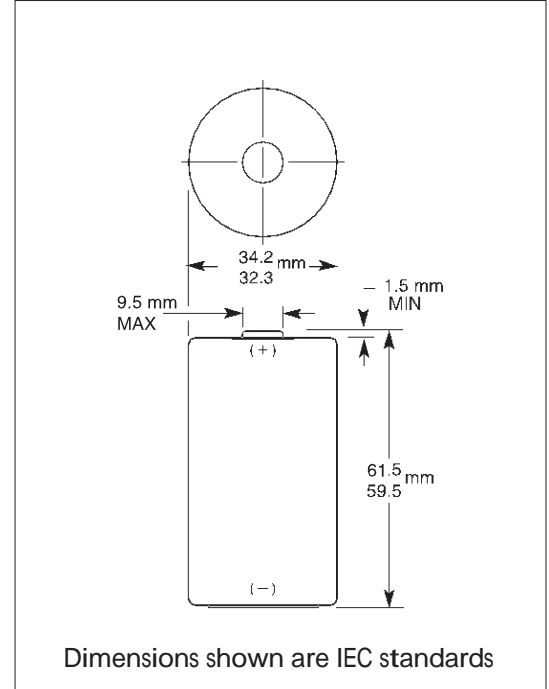

Berkshire Corporate Park  
Bethel, CT. 06801 U.S.A.  
Telephone: Toll-free 1-800-544-5454  
www.duracell.com

Delivered capacity is dependent on the applied load, operating temperature and cut-off voltage. Please refer to the charts and discharge data shown for examples of the energy/service life that the battery will provide for various load conditions.

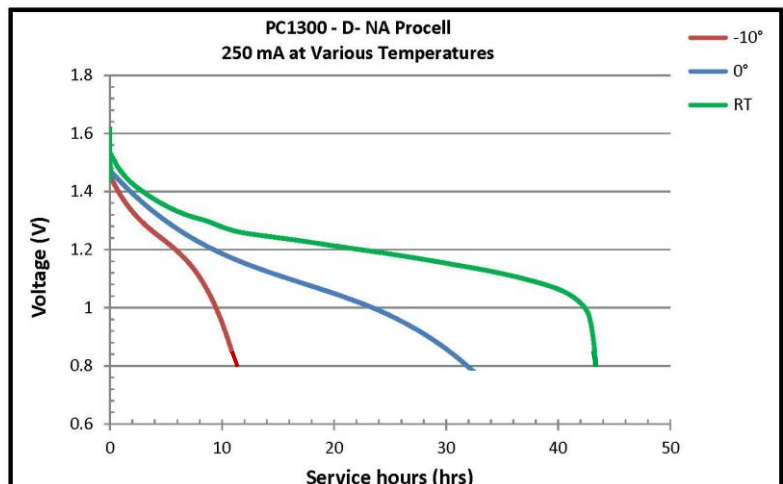
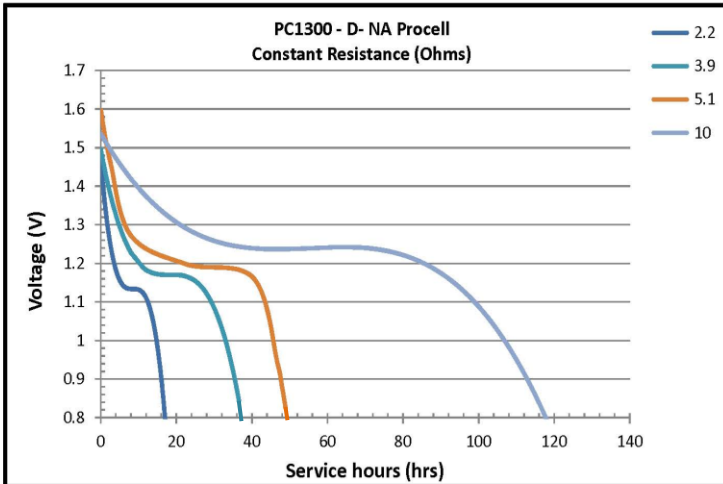
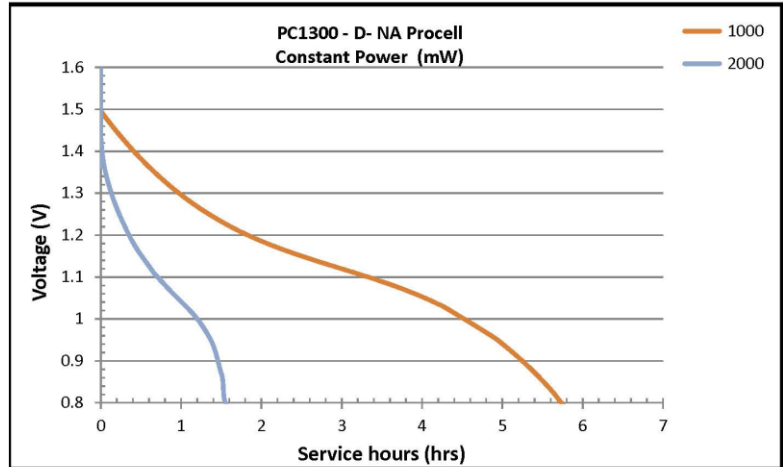
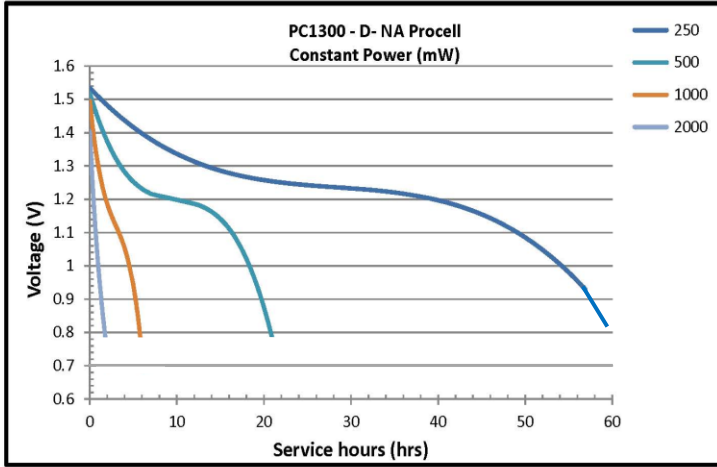

**DURACELL**  
BATTERIES

Berkshire Corporate Park  
Bethel, CT. 06801 U.S.A.  
Telephone: Toll-free 1-800-544-5454  
www.duracell.com

Delivered capacity is dependent on the applied load, operating temperature and cut-off voltage. Please refer to the charts and discharge data shown for examples of the energy/service life that the battery will provide for various load conditions.